



شركة الصناعات الوطنية
NATIONAL INDUSTRIES COMPANY
www.nicbm.com Since 1960 1 844 555

NIC Plastics



PPR - uPVC - cPVC



NIC Products



Interlock &
Yard Tiles



Limestone



Plastics



LED Lights



Dry Mortar



Cement
Cladding
Bricks



Ready Mix



Ceramics



White
Blocks



Benches &
Flower
Pots



Paints



Cladding



Concrete
Pipes



HDPE



NI Panels

introduction

"NIC PLASTIC" factory was established in 1982 in response to the ever increasing demand in Kuwait and neighbouring countries. This factory is considered one of the largest in the Middle East, with an annual production capacity reaching 8500 tones of uPVC pipes, and 500 tones fittings. NIC plastic pipes ranges from 16 to 400 mm., and are produced in accordance with international standard including: German (DIN), British (BS), American (ASTM), Saudi Arabia and Kuwait standards. NIC Plastic is capable of producing its products to other standards when required by our clients.

NIC Plastic factory produces the following Products catogaries:

NIC PPR Water Piping System for hot & cold water	2
NIC cPVC Hot & Cold Water Piping	6
NIC uPVC Water Piping System	10
NIC uPVC Sewerage & Drainage System.....	14
NIC uPVC Cable Ducts & Accessories.....	22
NIC uPVC Conduit Pipes & Accessories.....	24

“NIC PPR” Water Piping System

For hot & cold water

Polypropylene Random copolymer (PPR) system «NIC PPR» is ideal for all potable water piping requirements in typical residential (single and multistory), motel/hotel, mobile home, site offices, manufactured housing, Green houses, farms, light commercial and institutional structures. Typical uses of PPR pipes are as follows.

1. Hot and cold water pressure pipes.
2. Drinking water pressure pipes. (potable water)
3. Heating, air-conditioning & chilled water pressure pipes.
4. Irrigation pipes for green houses, garden and farms.
5. Compressed air conveying pipes.
6. Industrial Fluid conveying pipes.

Properties of PPR / PPR-CT

Property	Value	Unit	Standard
Density	0.91	g/cm ³	DIN 53479
Modulus of Elasticity	≥ 800	N/mm ²	DIN 53457
Vicat Softening Temperature	≥ 125	°C	ASTM D1525
Co-efficient of thermal expansion	≤ 1.5X10 ⁻⁴	K ⁻¹	DIN 53752
Thermal Conductivity	≤ 0.23	W/Km	DIN 52612-1
Tensile Strength	≥ 25	MPa	ASTM D 638
Heat Reversion	≤ 2	%	DIN 8078
Impact Resistance	Comply		DIN 8078

Advantages of PPR

1. Provides high resistance to chemicals, acids and other materials like lime and cement with which pipes may come into contact.
2. Poor electrical conductor, so pipes are not damaged by stray currents.
3. Excellent noise damping property, which is useful in places like hotels and hospitals.
4. Low thermal conductivity prevents heat loss when used in heating or cooling system.
5. Non toxic and complies with relevant international standards to use with drinking water.
6. Very smooth inner surface prevents pressure loss and also prevents sedimentary crusting inside pipe.
7. Light weight so easy to install and welding gives perfect leak proof joint.

Quality Standards.

Pipes as per DIN 8077 & DIN 8078

Fittings as per DIN 16962 & EN ISO 15874

Quality System as per BS EN ISO 9001 : 2000



PPR Pipes

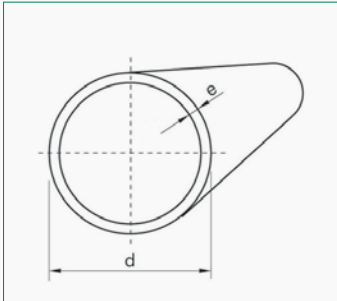

“NIC PPR” pipe sizes and wall thickness as per DIN 8077:2008

Pipe Size OD (mm)	PP - R			PP - RCT	
	PN 16	PN 20	PN 25	PN 20	PN 25
	S 3.2 SDR 7.4	S 2.5 SDR 6.0	S 2.0 SDR 5.0	S 3.2 SDR 7.4	S 2.5 SDR 6.0
20	2.8	3.4	4.1	2.8	3.4
25	3.5	4.2	5.1	3.5	4.2
32	4.4	5.4	6.5	4.4	5.4
40	5.5	6.7	8.1	5.5	6.7
50	6.9	8.3	10.1	6.9	8.3
63	8.6	10.5	12.7	8.6	10.5
75	10.3	12.5	15.1	10.3	12.5
90	12.3	15.0	18.1	12.3	15.0
110	15.1	18.3	22.1	15.1	18.3
160	21.9	26.6	32.1	21.9	26.6

To ensure long service life of “NIC PPR” pipes, it is necessary to refer following table, which is based on DIN 8077:2008

Allowable working pressure bars

Temp °C	Service Life Years	PP - R			PP - RCT	
		PN 16	PN 20	PN 25	PN 20	PN 25
		S 3.2 SDR 7.4	S 2.5 SDR 6.0	S 2.0 SDR 5.0	S 3.2 SDR 7.4	S 2.5 SDR 6.0
Allowable working pressure - BAR						
20	50	20.4	25.7	32.4	24.3	30.6
	100	19.9	25.0	31.5	24.0	30.2
30	50	17.2	21.7	27.4	20.9	26.4
	100	16.8	21.1	26.6	20.6	26.0
40	50	14.5	18.3	23.1	17.9	22.6
	100	14.1	17.8	22.4	17.6	22.2
50	50	12.2	15.4	19.4	15.2	19.2
	100	11.8	14.9	18.8	15.0	18.9
60	25	10.5	13.3	16.7	13.1	16.5
	50	10.2	12.9	16.2	12.8	16.2
70	25	8.0	10.0	12.7	10.9	13.8
	50	6.7	8.5	10.7	10.7	13.5
80	10	6.4	8.1	10.2	9.3	11.7
	25	5.1	6.5	8.1	9.1	11.4
95	5	4.1	5.2	6.5	7.1	8.9
110	1	3.4	4.3	5.5	6.9	8.7

PPR Fittings - PN : 25 Bars

"NIC PPR" Fittings as per DIN 16962 / EN ISO 15874



Elbow 90°
20, 25, 32, 40, 50, 63
75, 110



Equal Tee
20, 25, 32, 40, 50, 63
75, 110



Socket
20, 25, 32, 40, 50, 63
75, 110



End Cap
20, 25, 32, 40, 50, 63
75



Cross Over
20, 25, 32



Reduced Socket
25X20, 32X20, 32X25, 40X25,
40X32, 50X25, 50X32, 50X40,
63X25, 63X32, 63X40, 63X50
75X32, 75X40, 75X50, 75X63



Elbow 45°
20, 25, 32, 40, 50, 63
110



**Elbow Adapter
Female Threads**
20X1/2", 25X1/2", 25X3/4", 32X3/4",
32X1"



**Tee Adapter
Female Threads**
20X1/2", 25X1/2", 25X3/4", 32X3/4",
32X1"



Female Adapter
20X1/2", 25X1/2", 25X3/4", 32X1",
40X1/4", 50X1/2", 63X2"



Tee Reducing
25X20, 32X20, 32X25, 40X25,
40X32, 50X25, 50X32, 50X40,
63X25, 63X32, 63X50



Male Adapter
20X1/2", 25X1/2", 25X3/4", 32X1",
40X1/4", 50X1/2", 63X2"



Union
Plastic Threads
20, 25, 32



**Union Adapter
Male Threads**
20X1/2", 25X1/2", 25X3/4", 32X1",
40X1/4", 50X1/2", 63X2"



**Union Adapter
Female Threads**
20X1/2", 25X1/2", 32X1",
40X1/4", 50X1/2", 63X2"



**Elbow Adapter
Male Threads**
25X1/2", 25X3/4", 32X3/4"



**Tee Adapter
Male Threads**
25X1/2", 32X3/4"



**Body for Gate/
Concealed Valve**
25X3/4", 32X3/4", 32X1"



Slanted Valve
25, 32



Pipe Cutter
20 to 32



Welding Device
20 to 63

NIC cPVC

Hot & Cold Water Piping

"NIC PLASTICS" cPVC systems are ideal for all potable water piping requirements in typical residential (single and multi-family), motel/hotel, mobile home, site offices, manufactured housing, light commercial, and institutional structures.

The hot water from the heater will not affect the cPVC. So, cPVC systems is ideal for both hot and cold water lines. Generally, it is not necessary to insulate cPVC pipes to prevent heat loss from hot water piping, due to very low coefficient of thermal conductivity of cPVC compared to metallic materials.

cPVC can easily withstand the ultraviolet exposure commonly experienced during the construction phase of a project. If cPVC is used in above-ground, outdoor applications, protection from ultraviolet attack can be achieved by shielding or by painting the system with an exterior-grade latex paint.

When using cPVC with joints under slab, **YOU MUST PRESSURE TEST THE SYSTEM BEFORE POURING THE SLAB**. Also, it is wise to use 1" foam insulation pipe sleeve at changes in direction, where the pipe comes out of the slab, and at construction joints. The pipe should be evenly supported in smooth bottom trenches. The backfill should be free of rocks and debris.

In areas where there is a likelihood that stresses or impact abuse will occur, cPVC fittings with Bronze nickel plated threads are recommended. Such application examples are bath tub fillers, showerheads, and outside sillcocks. However, for closets, lavatories, and sinks ... cPVC fittings with plastic threads can also be used. Use of Teflon® tape is recommended over threads of cPVC fittings.

Properties of cPVC Pipes

• Vicat Softening Temperature @ 1 Kg. Load	119°C
• Vicat Softening Temperature @ 5 Kg. Load	110°C
• Tensile strength @ 20 °C	500 Kg/cm ² (minimum)
• Specific Gravity	1.55 gram/cm ³
• Water Absorption	less than 4 mg/cm ²

Benefits

1. cPVC is suitable for hot water coming from water heater and is also suitable for cold potable water.
2. cPVC is extremely quiet due to the polymeric structure of the product. Also, noise associated with water hammer is approximately 1/3 the intensity of copper or steel. cPVC systems are virtually silent.
3. cPVC is safe for drinking water. cPVC is also resistant to chemicals used in disinfecting potable water, ensuring long life of pipe.
4. cPVC does not corrode or accumulate material deposits. Due to smooth surface friction loss is very low.
5. Unlike PP/PE and other plastics, cPVC will not burn without a significant external flame source. Once a flame source is removed, cPVC will not sustain combustion.
6. cPVC is easy to cut with tubing cutter, a power saw, handsaw or a ratchet cutter. cPVC pipes and fittings are joined easily with help of solvent cement, without need of special heating or fusion equipments required with PP or PE.

cPVC Pressure Pipes for Hot & Cold Water

1. DIN 8079 / DIN 8080

Nominal Size mm	Outside Diameter mm		Wall Thickness mm		
			Series 6.3	Series 5	Series 4
	Min.	Max	PN 16	PN 20	PN 25
20	20.0	20.2	1.5	1.9	2.3
25	25.0	25.2	1.9	2.3	2.8
32	32.0	32.2	2.4	2.9	3.6
40	40.0	40.2	3.0	3.7	4.5
50	50.0	50.2	3.7	4.6	5.6
63	63.0	63.2	4.7	5.8	7.1
75	75.0	75.3	5.6	6.8	8.4
90	90.0	90.3	6.7	8.2	10.1
110	110.0	110.3	8.1	10.0	12.3
160	160.0	160.4	11.8	14.6	17.9

Length : 4 Meters Color : Light Yellow Socket : Nil

Note : Non-standard color, length and sizes can be manufactured.

2. ASTM F 441

Nominal Size Inch	Outside Diameter mm		Wall Thickness mm			
			Schedule 40		Schedule 80	
	Min.	Max	Min.	Max	Min.	Max
½"	21.24	21.44	2.77	3.28	3.73	4.24
¾"	26.57	26.77	2.87	3.38	3.91	4.42
1"	33.27	33.53	3.38	3.89	4.55	5.08
1¼"	42.03	42.29	3.56	4.06	4.85	5.44
1½"	48.11	48.41	3.68	4.19	5.08	5.69
2"	60.17	60.47	3.91	4.42	5.54	6.20

Length : 4 Meters Color : Grey Socket : Nil

Note : Non-standard color, length and sizes can be manufactured.

It is important to select appropriate pipe series according to temperature and working pressure. Please use following table with details taken from DIN 8079:2009-10

Temperature °C	Years of Service	Allowable working pressure bar		
		Series 6.3 PN 16	Series 5 PN 20	Series 4 PN 25
20	50	16.0	20.0	25.0
	100	15.5	19.5	24.5
40	50	11.3	14.2	17.9
	100	10.9	13.8	17.3
60	25	7.3	9.2	11.6
	50	7.0	8.8	11.4
80	5	4.2	5.2	6.6
	10	3.9	4.9	6.2
95	1	2.3	2.9	3.6
	2	2.1	2.7	3.4

cPVC Pressure Fittings for Hot & Cold Water

DIN 8079 / DIN 8080



Coupler

20, 25, 32, 40, 50, 63
75, 90, 110



Elbow 90°

20, 25, 32, 40, 50, 63
75, 90, 110



Elbow 45°

20, 25, 32, 40, 50, 63
75, 90, 110



Tee

20, 25, 32, 40, 50, 63
75, 90, 110



End Cap

20, 25, 32, 40, 50, 63



Saddle Clip

20, 25, 32



Cross Over

25



Reduced Tee

63x20, 63x25, 63x32,
63x40, 63x50



Male Adapter
Plastic threads
20x1/2", 25x3/4"
32x1", 40x1 1/4"
50x1 1/2", 63x2"



Male Adapter
Ni Plated Bronze Threads
25x3/4", 32x1"
40x1", 40x1 1/4"
50x1 1/4", 50x1 1/2"
63x1 1/2", 63x2"



Female Adapter
Plastic threads
40x1 1/4", 50x1 1/2",
63x2"



Female Adapter
Ni Plated Bronze Threads
20x1/2", 25x1/2",
25x3/4", 32x3/4", 32x1"
40x1", 40x1 1/4"
50x1 1/4", 50x1 1/2"
63x1 1/2", 63x2"



Threaded Elbow 90°
Ni Plated Bronze Threads
20x1/2", 25x1/2",
25x3/4", 32x3/4", 32x1"



Threaded Tee
Ni Plated Bronze Threads
20x1/2", 25x1/2",
25x3/4", 32x3/4", 32x1"



Reducer Bush

25x20, 32x20, 32x25
40x25, 40x32, 50x32
50x40, 63x32, 63x50
75x63, 90x75, 110x90



Threaded Reducer Bush

25x1/2", 32x1/2",
32x3/4", 40x3/4", 40x1"
50x1", 50x1 1/4", 63x1 1/2"

NIC uPVC

Water Piping System

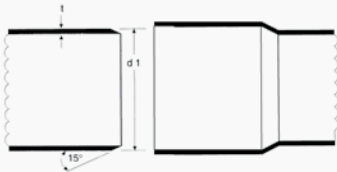

Solvent joint socket
Diameter 20mm to 400mm

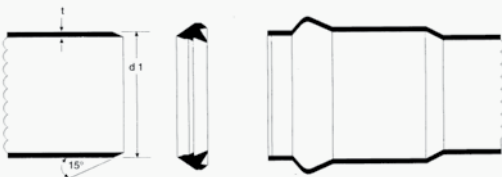

Rubber joint socket
(Anger Ring – System 3S)
Diameter 75mm to 400xmm

"NIC PLASTICS" uPVC systems are ideal for all potable water piping requirements in typical residential (single and multistory), motel/hotel, mobile home, site offices, manufactured housing, light commercial and institutional structures. "NIC PLASTICS" uPVC pressure piping system is also ideal for irrigation water supply system and fire fighting water supply system.

uPVC pressure piping system is used extensively underground and inside building. It can also be used in outdoor, above ground installation provided, such pipes and fittings are protected from exposure to direct sunlight.

"NIC PLASTICS" uPVC piping system do not rust, scale or corrode. uPVC piping system are not chemically reactive with the drinking water they convey. Consequently, uPVC piping systems do not adversely affect water quality or taste. In general, uPVC pipes have been tested and certified in accordance with drinking water standards, for more than 35 years, around the world.

Properties of uPVC Pipes

Vicat Softening Temperature @ 1 Kg. Load	85°C
Vicat Softening Temperature @ 5 Kg. Load	80°C
Tensile strength @ 20°C	500 Kg/cm ² (minimum)
Specific Gravity	1.45 gram/cm ³
Water Absorption	less than 4 mg/cm ²

uPVC Pressure Pipes for Drinking / Irrigation Water

1. DIN 8061 / DIN 8062

Nominal Size mm	Outside Diameter mm		Wall Thickness mm			
			Series 25	Series 16.7	Series 10	Series 6.3
	Min.	Max	4 Kg/cm ²	6 Kg/cm ²	10 Kg/cm ²	16 Kg/cm ²
20	20.0	20.2				1.5
25	25.0	25.2				1.9
32	32.0	32.2			1.6	2.4
40	40.0	40.2			1.9	3.0
50	50.0	50.2		1.5	2.4	3.7
63	63.0	63.2		1.9	3.0	4.7
75	75.0	75.3	1.5	2.2	3.6	5.6
90	90.0	90.3	1.8	2.7	4.3	6.7
110	110.0	110.3	2.2	3.2	5.3	8.1
160	160.0	160.4	3.2	4.7	7.7	11.8
200	200.0	200.4	3.9	5.9	9.6	14.7
250	250.0	250.5	4.9	7.3	11.9	18.4
315	315.0	315.6	6.2	9.2	15.0	23.2
400	400.0	400.7	7.9	11.7	19.1	29.4

Length : 4, 5.8 & 6 Meters

Colour : Grey

Socket : Solvent & Rubber (3S)

To ensure long service life of uPVC Pressure pipes, it is necessary to select series of pipe based on temperature. Following table is prepared from details given in standard DIN 8062:2009-10.

Temperature °C	Years of Service	Allowable working pressure - bar			
		Series 25 4 Kg/cm ²	Series 16.7 6 Kg/cm ²	Series 10 10 Kg/cm ²	Series 6.3 16 Kg/cm ²
20	50	4.0	6.0	10.0	16.0
	100	3.9	5.8	9.7	15.6
30	25	3.3	4.9	8.2	13.2
	50	3.2	4.8	8.0	12.7
40	25	2.5	3.7	6.2	9.9
	50	2.4	3.6	6.0	9.6
50	10	1.8	2.7	4.6	7.3
	25	1.7	2.6	4.3	6.9
60	10	1.1	1.7	2.8	4.5
	25	1.1	1.6	2.6	4.2

uPVC Pressure Pipes for Drinking / Irrigation Water

BS EN ISO 1452 : 2009

Nominal Size mm	Outside Diameter mm		Wall Thickness mm – Design Coefficient C=2.5			
			Series 16	Series 10	Series 6.3	Series 5
	Min.	Max	6 Kg/cm ²	10 Kg/cm ²	16 Kg/cm ²	20 Kg/cm ²
20	20.0	20.2			1.5	1.9
25	25.0	25.2			1.9	2.3
32	32.0	32.2		1.6	2.4	2.9
40	40.0	40.2	1.5	1.9	3.0	3.7
50	50.0	50.2	1.6	2.4	3.7	4.6
63	63.0	63.2	2.0	3.0	4.7	5.8
75	75.0	75.3	2.3	3.6	5.6	6.8
90	90.0	90.3	2.8	4.3	6.7	8.2

Nominal Size mm	Outside Diameter mm		Wall Thickness mm – Design Coefficient C=2.0			
			Series 20	Series 12.5	Series 8	Series 6.3
	Min.	Max	6 Kg/cm ²	10 Kg/cm ²	16 Kg/cm ²	20 Kg/cm ²
110	110.0	110.3	2.7	4.2	6.6	8.1
160	160.0	160.4	4.0	6.2	9.5	11.8
200	200.0	200.4	4.9	7.7	11.9	14.7
250	250.0	250.5	6.2	9.6	14.8	18.4
315	315.0	315.6	7.7	12.1	18.7	23.2
400	400.0	400.7	9.8	15.3	23.7	29.4

ASTM D 1785

Nominal Size Inch	Outside Diameter mm		Wall Thickness mm			
			Schedule 40		Schedule 80	
	Min.	Max	Min.	Max	Min.	Max
1/2	21.24	21.44	2.77	3.28	3.73	4.24
3/4"	26.57	26.77	2.87	3.38	3.91	4.42
1"	33.27	33.53	3.38	3.89	4.55	5.08
1 1/4"	42.03	42.29	3.56	4.06	4.85	5.44
1 1/2"	48.11	48.41	3.68	4.19	5.08	5.69
2"	60.17	60.47	3.91	4.42	5.54	6.20
4"	114.07	114.53	6.02	6.73	8.56	9.58

Length : 4, 5.8 & 6 Meters

Colour : White / Grey

Socket : Solvent / Rubber

uPVC Pressure Fittings for Drinking / Irrigation Water

DIN 8063



Coupler

20, 25, 32, 40, 50, 63
75, 90, 110



Elbow 90°

20, 25, 32, 40, 50, 63
75, 90, 110



Elbow 45°

20, 25, 32, 40, 50, 63
75, 90, 110



Tee

20, 25, 32, 40, 50, 63
75, 90, 110



End Cap

20, 25, 32, 40, 50, 63



Saddle Clip

20, 25, 32



Cross Over

25



Reduced Tee

63x20, 63x25, 63x32,
63x40, 63x50



Male Adapter
Plastic threads

20x1/2", 25x3/4", 32x1",
40x1 1/4", 50x1 1/2", 63x2"



Male Adapter
Ni plated Bronze threads

25x3/4", 32x1",
40x1", 40x1 1/4",
50x1 1/4", 50x1 1/2",
63x1 1/2", 63x2"



Female Adapter
Plastic threads

40x1 1/4", 50x1 1/2",
63x2"



Female Adapter
Ni plated Bronze threads

20x1/2", 25x1/2",
25x3/4", 32x3/4", 32x1",
40x1", 40x1 1/4",
50x1 1/4", 50x1 1/2",
63x1 1/2", 63x2"



Threaded Elbow 90°

20x1/2", 25x1/2", 25x3/4",
32x3/4", 32x1"



Threaded Tee

20x1/2", 25x1/2", 25x3/4",
32x3/4", 32x1"

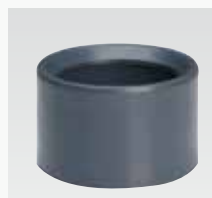

Reducer Bush

25x20, 32x20, 32x25
40x25, 40x32, 50x32
50x40, 63x32, 63x50
75x63, 90x75, 110x90



Threaded Reducer Bush

25x1/2", 32x1/2", 20x3/4",
40x1", 50x1" 50x1 1/4",
63x1 1/2"

NIC uPVC

Sewerage & Drainage System

"NIC PLASTICS" uPVC sewerage and drainage system is used extensively underground and inside building. uPVC piping system do not allow any leakage or seepage of sewage and thus prevent escape of harmful bacteria and viruses into environment. uPVC piping do not react to soil contaminants or acidity nor the waste water or the sewage passing through it. In addition, smooth & uniform surface of uPVC piping gives better hydraulic flow and fewer blockages.

Typical applications: Building sewers and underground building drains for home and industry, building storm sewers for home and industry, disposal fields for septic tank drains and leaching systems, subsoil drains for lowland and surface water drainage, sewer mains and sewer service.

Properties of uPVC Pipes

• Vicat Softening Temperature @ 1 Kg. Load	85 °C
• Vicat Softening Temperature @ 5 Kg. Load	80 °C
• Specific Gravity	≈1.45 gram/cm ³
• Water Absorption	less than 4 mg/cm ²

"NIC PLASTICS" uPVC Pipes are available in three type of sockets. This socket helps in connecting one pipe with another

uPVC Sewerage & Drainage Pipe Joints

Solvent joint socket
Diameter 20mm to 400mm

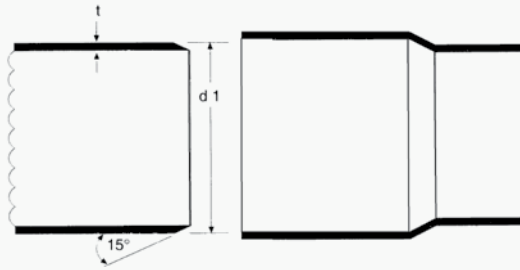

Rubber joint socket
O Ring – System BL
Diameter 50mm to 250mm

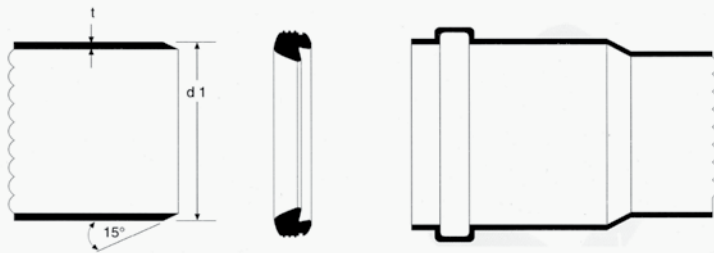

Rubber joint socket
Anger Ring – System 3S
Diameter 110 mm to 400mm

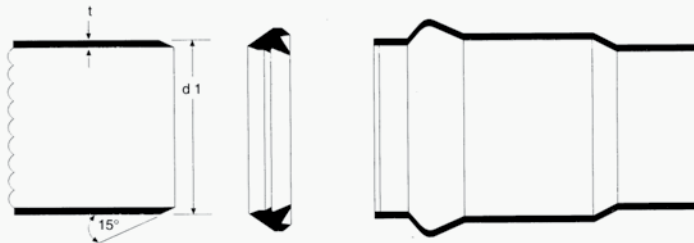

uPVC Pipes for Sewerage, Drainage, Ventilation & Rain Water

1. DIN STANDARD

Nominal Size mm	Outside Diameter mm		Wall Thickness mm				
	Min.	Max	DIN 8062 4 Kg/cm ²	DIN 8062 6 Kg/cm ²	DIN 19534	DIN 19531	Special
50	50.0	50.2		1.8		1.8	2.2
63	63.0	63.2		1.9			
75	75.0	75.3	1.8	2.2		1.8	2.6
90	90.0	90.3	1.8	2.7			4.5
110	110.0	110.3	2.2	3.2	3.0	2.2 & 3.0	1.8
160	160.0	160.4	3.2	4.7	3.6	3.2 & 3.6	2.8
200	200.0	200.4	4.0	5.9	4.5		
250	250.0	250.5	4.9	7.3	6.1		
315	315.0	315.6	6.2	9.2	7.7		
400	400.0	400.7	7.9	11.7	9.8		

Length : 4, 5.8 & 6 Meters

Colour : Light Grey / Golden Brown

2. BRITISH STANDARD

Nominal Size Inch	Outside Diameter mm		Wall Thickness mm								
	Min.	Max	BS EN 1329-1		BS EN 1401-1			BS 5255	BS 4514	BS 4660	BS 5481
			B	BO	SDR51 SN2	SDR41 SN4	SDR34 SN8				
-	32.0	32.2	3.0								
1 1/4"	36.2	36.5	3.0					1.8			
-	40.0	40.2	3.0								
1 1/2"	42.8	43.1	3.0					1.9			
-	50.0	50.2	3.0								
2"	55.8	56.1	3.0					2.0			
-	75.0	75.3	3.0	3.0							
3"	82.4	82.8	3.0	3.0					3.0		
4"	110.0	110.3	3.2	3.2		3.2	3.2		3.2	3.2	
6"	160.0	160.4	3.2	4.0	3.2	4.0	4.7		3.3	4.1	
8"	200.0	200.4	3.9	4.9	3.9	4.9	5.9				4.9
10"	250.0	250.5	4.9	6.2	4.9	6.2	7.3				6.1
12"	315.0	315.6	6.2	7.7	6.2	7.7	9.2				7.7
16"	400.0	400.7			7.9	9.8	11.7				9.8

Length : 4, 5.8 & 6 Meters

Colour : Light Grey / Golden Brown

Note : Non-standard colour, length and sizes can be manufactured.

uPVC Sewerage Fitting for Inside Building Installations

As per BS 4660 & exceeds requirements of DIN 19531 / 19534,
Suitable to use with all DIN & BS pipes of "NIC PLASTICS"



All above fittings are also available in Light Grey colour for inside building installation.

uPVC Sewerage Fitting for Inside Building Installation

As per DIN 19531 & exceeds requirements of DIN 19531 / 19534

Suitable to use with all DIN standard pipes of "NIC PLASTICS"



Coupler
Rubber Socket
50, 75, 200 & 250mm



Coupler
Solvent Socket
50 & 75mm



Short Coupler
Solvent Socket
50mm



Reducer
Rubber Socket
110x50, 110x75mm



Reducer
Solvent Socket
110x50, 110x75mm



Elbow 87.5°
Rubber Socket
50 & 75mm



Elbow 87.5°
Solvent Socket
50 & 75mm



Elbow 87.5°
Solvent Socket
50mm



Elbow 45°
Rubber Socket
50 & 75mm



Elbow 45°
Solvent Socket
50 & 75mm



Elbow 45°
Solvent Socket
50mm



Threaded Elbow
Solvent Socket
50mm x 1 1/2"



Junction 87.5° (T)
Rubber Socket
50 & 75mm

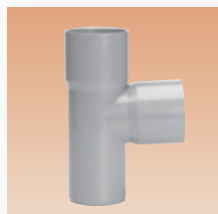

Junction 87.5° (T)
Solvent Socket
50 & 75mm

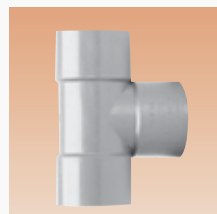

Junction 87.5° (T)
Solvent Socket
50mm



Reduced Junction
87.5° (T)
Rubber Socket
110x50, 110x75mm
75x50mm

uPVC Sewerage Fitting for Inside Building Installatoin

As per DIN 19531 & exceeds requirements of DIN 19531 / 19534

Suitable to use with all DIN standard pipes of "NIC PLASTICS"

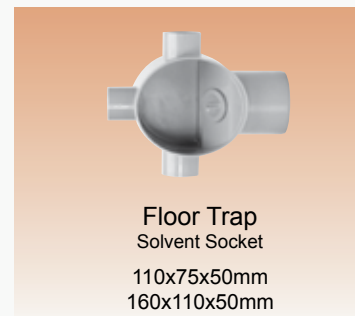
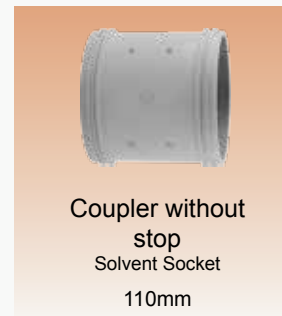

uPVC Sewerage Fitting for Inside Building Installatoin

2" (65mm) as per BS 5255 & EN 1329-1 & 3" (82mm) as per BS 4514

Suitable to use with BS 5255, EN 1329-1 & BS 4514 pipes of "NIC PLASTICS"



British Standard Pipes

Nominal Size (Inch)	Outside Diameter (mm)		BS 5255	BS 4514	Wall Thickness (mm) EN 1329-1	Special
	min.	max.				
2"	55.75	56.05	2.0		3.0	
3"	82.40	82.80		3.2		2.2



400X160mm



400X110mm

uPVC Inspection Chamber BS EN13598-1 (Cleanout / Sampling / Access Chamber)

The Property chamber 400X110mm and 400X160mm are injection molded from uPVC with three inlet and one outlet, all designed to prevent deposition of solids. All four sides have rubber seals to provide leak proof joint with connecting uPVC pipes of outer diameter 110mm and 160mm, all rubber seals are designed for 4bar pressure. One can use socket plug to close one of the branches. Top Shaft (Riser Pipe) 400X7.9mm, 1meter height supplied to raise the height. Riser pipe length can be supplied as per customer's requirement.

Benefits and Features

- Economical to purchase, install and maintain.
- Reduced installation time and costs when compared to brick and concrete manholes.
- Angular adjustments for a neat finish on sloped areas.
- Allows safe and convenient cleaning, rodding and CCTV access.
- Increased flow characteristics designed by computer aided design.

All rubber seals are designed for 4 Bar pressure. Assembly is tested at 1 bar hydraustatic pressure in lab.

All four sides will have rubber seals to provide leak proof joint with connecting uPVC pipes of outer diameter 160mm

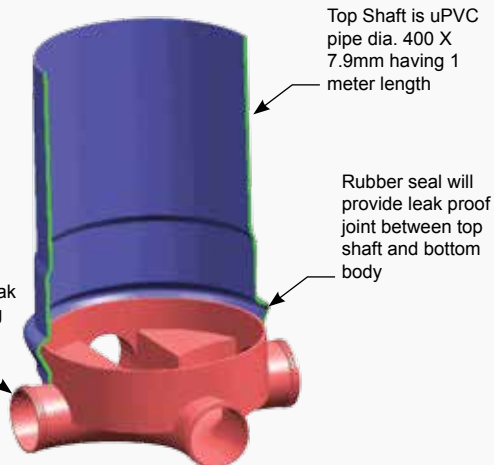

Top Shaft is uPVC pipe dia. 400 X 7.9mm having 1 meter length

Rubber seal will provide leak proof joint between top shaft and bottom body

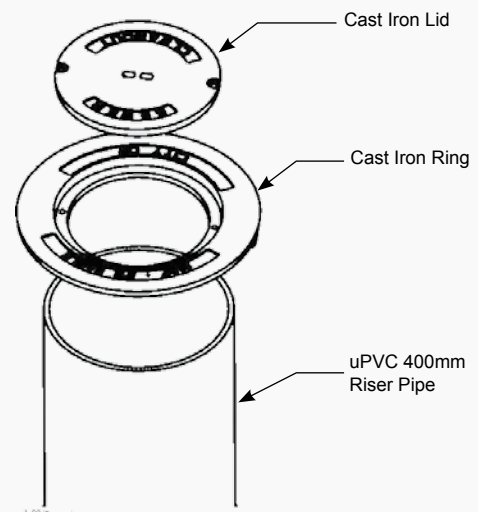

Cast Iron Lid

Cast Iron Ring

uPVC 400mm Riser Pipe



Site work

Clean 110mm or 160mm pipes having chamfered end and apply the lubricant then push directly into the required inlets, adaptors are not necessary. Use socket plug to close one of the branches, if don't have pipe connection.

The property chamber is bedded either direct on the trench bottom or on granular material or concrete. Selected backfill is then hand packed and rammed firmly around the chamber until adequate support is achieved.

The chamber is not designed to withstand heavy traffic loads, particularly during construction, and care should be exercised at this stage. A concrete collar formed in site maybe the most effective means of providing such protection.

Where wheel loads in excess of 1 metric Ton is expected, a heavier duty cover should be fitted and additional support should be provided. This should consist of either a concrete ring or a full concrete bed and surround.

Both 400X110mm and 400X160mm chambers are available as a base only. At site top riser shaft with sealing ring is assembled.

Installation details

- Excavate the hole for the chamber allowing sufficient working space around the outside of the chamber.
- Install the chamber base unit to the correct invert level and orientation. Bedding material should be used to give firm support to the base of the chamber, which should be installed with its top edge as level as possible.
- Pipe work should be connected to the main run and any of the side branches at this stage.
- Backfill in 150mm layers of selected as-dug or granular material, well compacted, as work proceeds.
- The chamber unit is built up to the required depth using standard top shaft of uPVC pipe diameter 400 X 7.9mm, having 1000mm height. The required combination of top shaft should be planned before work commences.
- To fit the first top shaft, locate the shaft seal by positioning the supplied sealing ring on the inside of the groove of the shaft, make sure that the thick end of ring is placed towards inner side of shaft socket – do not use lubricant.
- Clean and Lubricate the spigot on the chamber body and position the shaft centrally on the chamber. Push the shaft downwards until fully located.
- Backfill in 150mm layers of selected as-dug or granular material, well compacted, as work proceeds.

NIC uPVC

Cable Ducts & Accessories

"NIC PLASTICS" uPVC cable ducts and accessories meets all requirements of local governmental bodies like MOC, NHA & MEW. "NIC PLASTICS" uPVC cable ducts are tested from time to time by third party and they are approved by all concern local governmental bodies.

uPVC Cable Ducts

Nominal Size mm	Outside Diameter mm		Wall Thickness mm				
	Min.	Max	MOC & NHA	MEW	MEW Crossing Road	DIN 8062 4 Kg/cm ²	DIN 8062 6 Kg/cm ²
50	50.0	50.2	3.0	2.2	3.0		1.8
75	75.0	75.3		2.6	3.6	1.8	2.2
90	90.0	90.3	4.5			1.8	2.7
110	110.0	110.3	4.5	3.2	4.5	2.2	3.2
160	160.0	160.4	5.0	3.6	5.0	3.2	4.7
200	200.0	200.4		4.5	7.7	4.0	5.9
250	250.0	250.5				4.9	7.3
315	315.0	315.6		7.7	12.1	6.2	9.2
400	400.0	400.7				7.9	11.7

Length: 4, 5.8 & 6 Meters

Colour: Light Grey

Socket: Solvent socket

Note: Non-standard colour, length and sizes can be manufactured.

uPVC Cable Duct Accessories

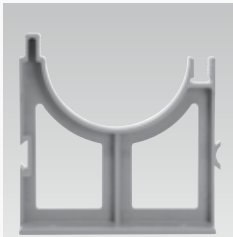

Base Spacer

110,160 & 200 mm

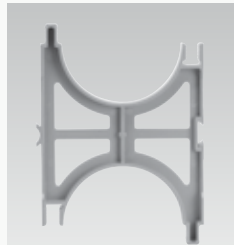

Intermediate Spacer

110,160 & 200 mm



Coupler

50,75,110,160 & 200 mm



Coupler without stop (Repair)
110mm & 160mm

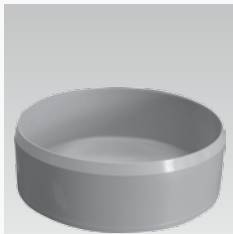

Pipe Plug

110,160 & 200 mm



Socket Plug

110,160 & 200 mm



Bell Mouth Ends

50,75,90,110,160,200,315

Lenght
200mm
&
300mm

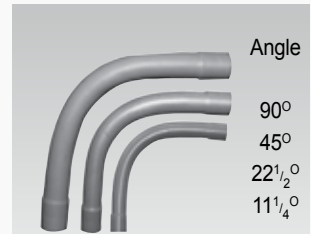

Long Radius Bends

50,75,90,110,160,200,315
Radius as required

Angle

90°
45°
22¹/₂°
11¹/₄°

All above fittings are in Light Grey colour

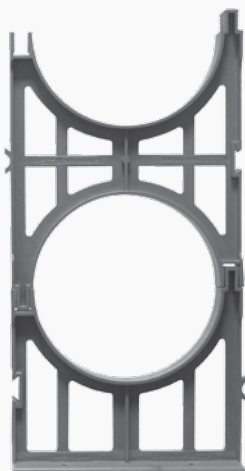

**Spacer
200mm**

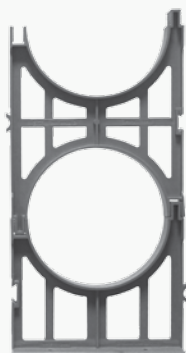

**Spacer
160mm**



**Spacer
110mm**

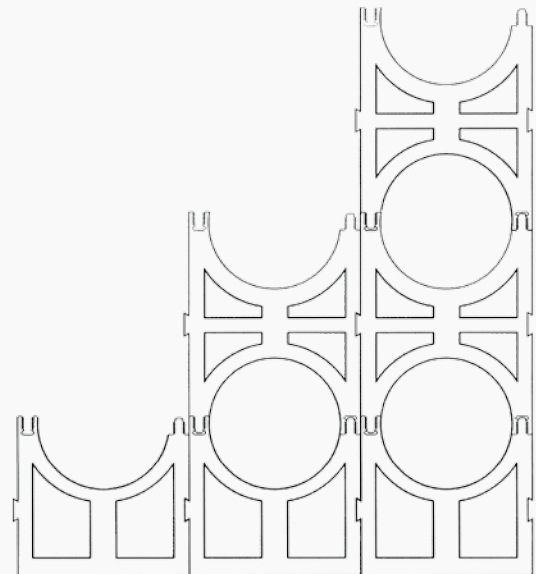

**Pipes can be organised in rows
and columns by using spacers**

NIC uPVC

Conduit Pipes & Accessories

"NIC PLASTICS" uPVC conduit pipes and accessories are non corroding unlike steel conduit system. uPVC conduit system is self extinguishing. uPVC conduit system is very easy to install and it is very economical. uPVC conduit system has very good insulation property compared to other conduit systems.

uPVC Conduit Pipes

As per BSEN 50086, BS 6099/2 & KSS 230 & 231

Nominal Size (OD) mm	Light (Yellow)		Medium (Blue)		Heavy (Red)	
	Min. Inside Diameter	Wall. Thickness	Min. Inside Diameter	Wall. Thickness	Min. Inside Diameter	Wall. Thickness
20	17.4	1.3	16.9	1.55	15.5	1.9
25	22.1	1.5	21.4	1.8	20.6	2.0
32	28.6	1.5	27.8	2.1	26.6	2.5
38	34.8	1.6	33.6	2.2	33.0	2.5
50	45.1	1.8	44.3	2.2	43.2	2.5 / 3.2

Length: 2, 9, 3 Meters

Colour: Black, Gray

Socket: Solvent socket.

Notes:

1. Conduit dimensions are as per BS 6099 except size 38 mm.
2. Size 38 mm is non standard size, but 38 mm pipe meets all requirements of Kuwaiti and British standards except size.
3. Light (yellow), Medium (Blue) & Heavy (Red) are groups, made based on thickness of conduits, but all three groups meets requirements of Kuwaiti and British Standards.
4. Normally pipes are supplied with integrated sockets, but pipes without integrated socket (plain ends) can be manufactured on request.
5. Non - standard colour, length and size can be manufactured request.

uPVC Conduit Pipes & Accessories

As per BS 4607 & Kss 320 & 231



Junction Box
1 – Way
2BA & M4 threads
20 & 25 mm



Junction Box
2 – Way Angel
2BA & M4 threads
20 & 25 mm



Junction Box
2 – Way Thru
2BA & M4 threads
20 & 25 mm



Junction Box
3 – Way
2BA & M4 threads
20 & 25 mm



Junction Box
4 – Way
2BA & M4 threads
20 & 25 mm



Junction Box
H – Way
2BA & M4 threads
20 mm



Junction Box
U – Way
2BA & M4 threads
20 mm



Junction Box
Y – Way
2BA & M4 threads
20 mm



Extension Ring
2BA & M4 threads
65 mm

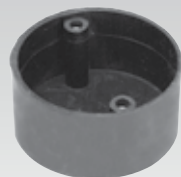

Loop - in - Boxes
2BA & M4 threads
65 mm



Female Adapter & nut
20,25,32
38 & 50 mm



Double Female
Adapter & Nuts
20 mm

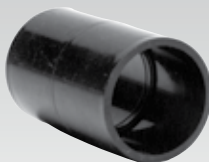

Couplers
20,25,32
38 & 50 mm



Saddle With Base & Screws
20,25,32
38 & 50 mm



Reducer
25 & 20 mm



Circular Lid
65mm

uPVC Electrical Accessories

As per BS 4607 & Kss 320 & 231

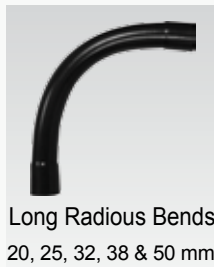
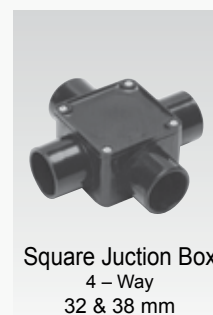
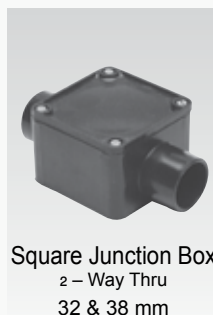
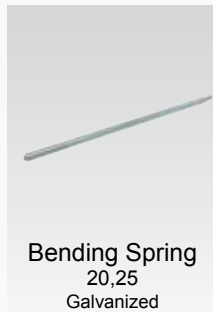
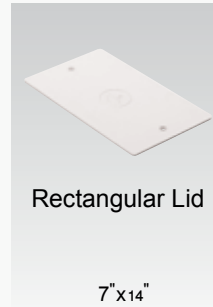

All above fittings are also available in White colour

Sales Outlet



Headquarter Shuwaikh

Tel: 24642100
Kuwait Hotline: 1844555
Ceramics Sales: 24836564

Working Hours*:

Morning Hours (Sunday - Thursday)

7:30am - 3:00pm

Evening Hours (Sunday - Wednesday)

5:00pm - 8:00pm

Saturday

7:30am - 2:00pm



Sulaihiya

Tel: 24642200

Working Hours*:

Saturday

7:30am - 2:00pm

Sunday - Thursday

7:30am - 3:00pm



Industrial Shuwaikh Showroom

Industrial Shuwaikh2 - Block1 - Area 92

Al-Zaben Complex - Shops : 12,13,14

Tel. : 24642101/2/3/4/9

Fax : 24642110

Working Hours*:

Saturday - Thursday

7:00am-7:00pm for plastic products

9:00am-9:00pm for other products



Western Industrial Shuaiba

Tel: 24642300
Ceramics Factory: 23262714/10

Working Hours*:

Sunday - Thursday

7:30am - 3:00pm

Saturday

7:30am - 2:00pm

Ceramics Showroom

Industrial Shuwaikh - Humaidhi Complex



Opposite to Bin Nisf Co.

Tel: 24950871/2 - Factory: 23262714/10

Working Hours*:

Sunday - Thursday: 9:00am - 9:00pm

For any sales inquiry: Fax: +965 24642063 - Email: sales@nicbm.com

* Working hours are subject to change according to holidays and occasions - Follow us on    +965 99001150



NATIONAL INDUSTRIES COMPANY



شركة الصناعات الوطنية

Since 1960

www.nicbm.com

1 844 555

